

## MC 58

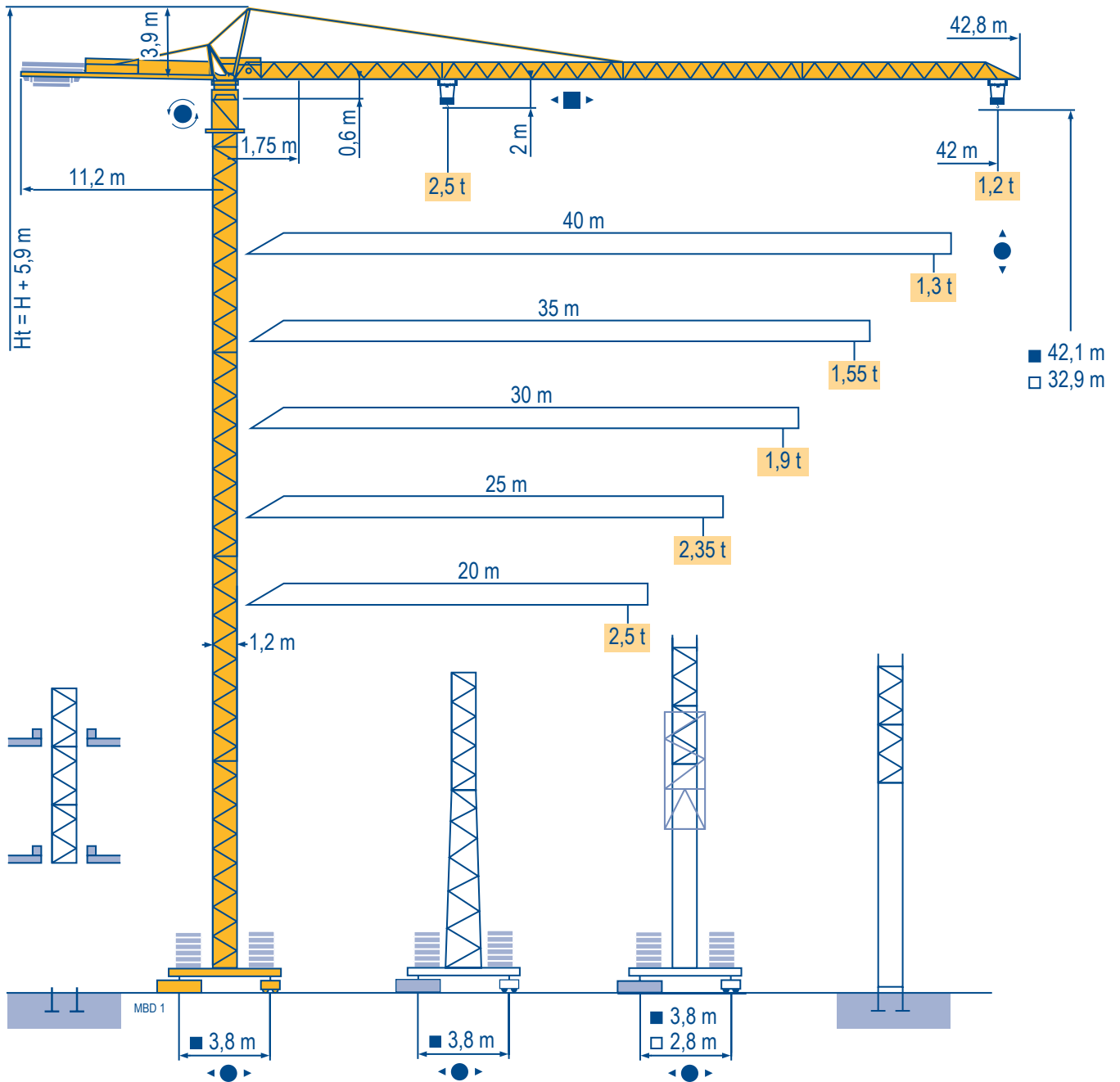

# CITY CRANE

CE FEM 1.001-A3

Mat / Réactions □ 1,2 m  
 Maste / Eckdrücke ▴ 20 m ⇒ 42 m  
 Masts / Reactions  
 Mástil / Reacciones  
 Torre / Reazioni  
 Tramo / Reações

MBD 3

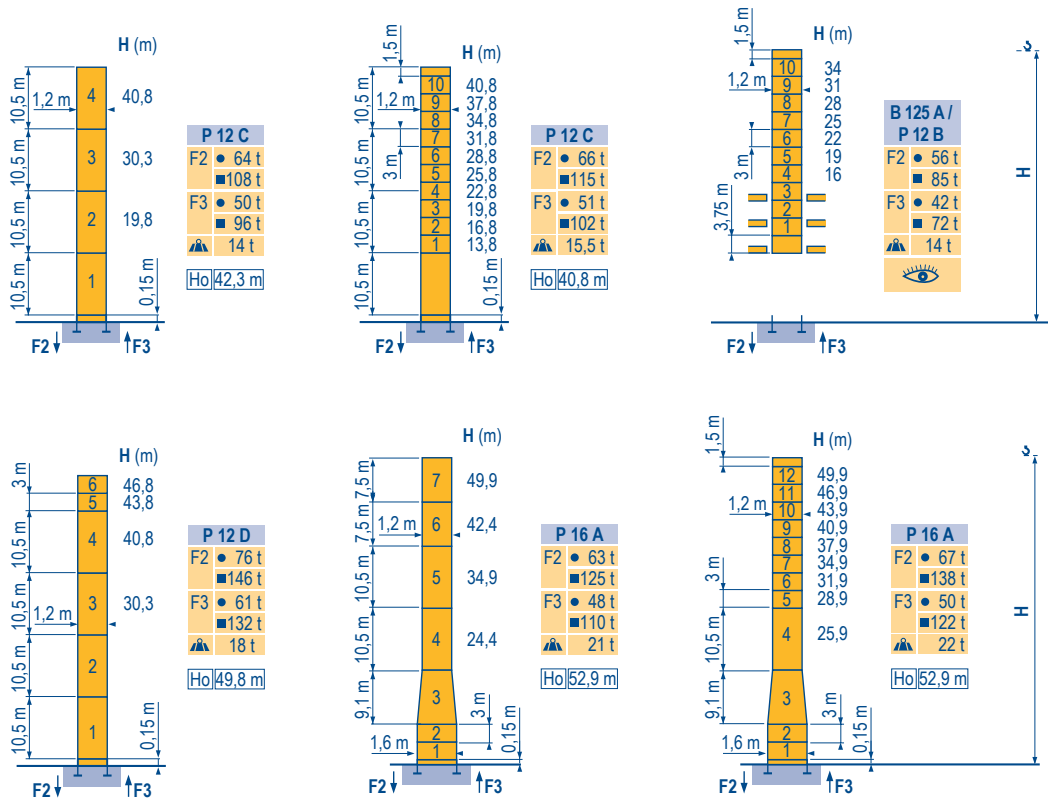

□ 1,2 m  
 ▴ 20 m ⇒ 42 m

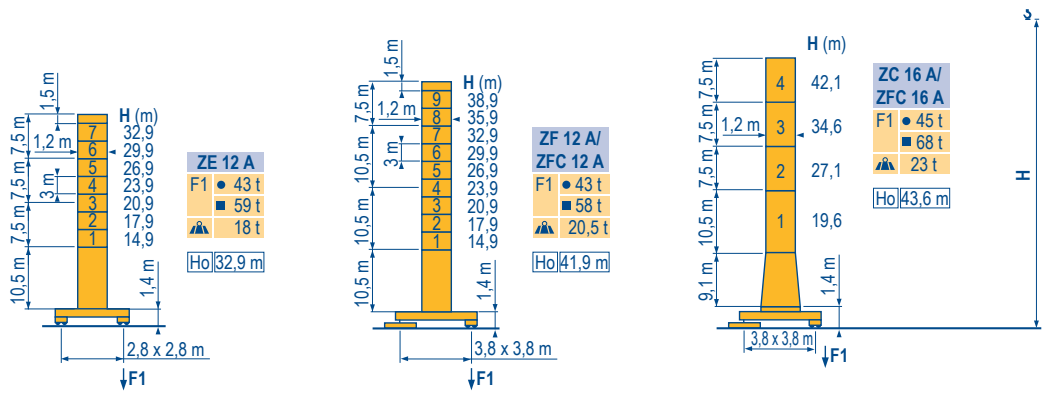

ZE - ZF - ZC - ZFC

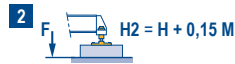

**CITY CRANE  
 MC 58**



F	D	GB	E	I	P
● Réactions en service	Reaktionskräfte in Betrieb	Reactions in service	Reacciones en servicio	Reazioni in servizio	Reações em serviço
■ Réactions hors service	Reaktionskräfte außer Betrieb	Reactions out of service	Reacciones fuera de servicio	Reazioni fuori servizio	Reações fora de serviço
▲ A vide sans lest (ni train de transport) avec flèche et hauteur maximum.	Ohne Last, Ballast (und Transportachse), mit Maximalausleger und Maximalhöhe.	Without load, ballast (or transport axles), with maximum jib and maximum height.	Sin carga, sin lastre, (ni tren de transporte), flecha y altura máxima.	A vuoto, senza zavorra (ne assali di trasporto) con braccio massimo e altezza massima.	Sem carga (nem trem de transporte)- sem lastro com lança e altura máximas.
Ho H sans cabine	H Ohne Fahrerhaus	H without cab	H sin cabina	H senza cabina	H sem cabine

**Courbes de charges**  
**Lastkurven**  
**Load diagrams**  
**Curvas de cargas**  
**Curve di carico**  
**Curva de cargas**

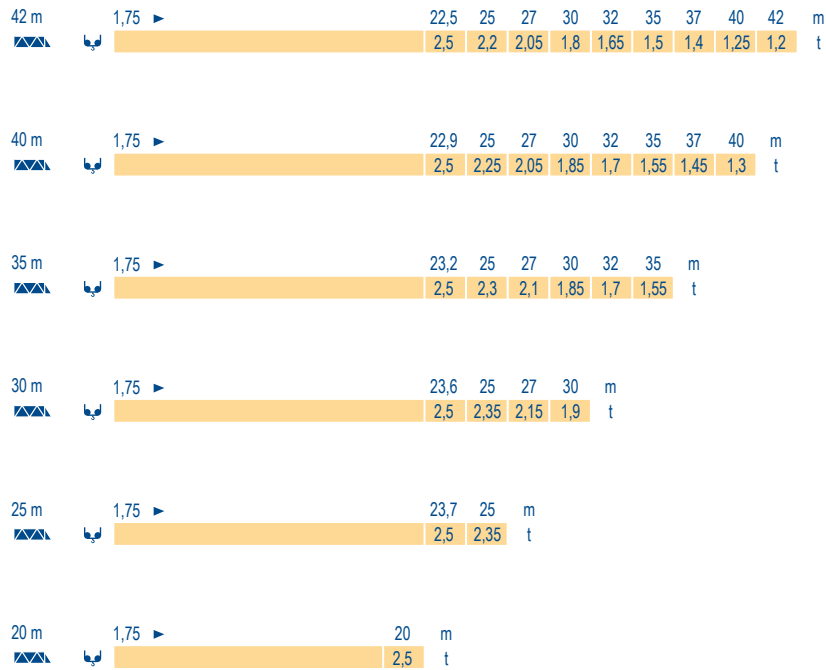

MBD 1

**Télescopage sur dalles**  
**Kletterkrane im Gebäude**  
**Climbing crane**  
**Telescopage gruas trepadoras**  
**Gru in cavedio**  
**Telescopagem sobre lages**

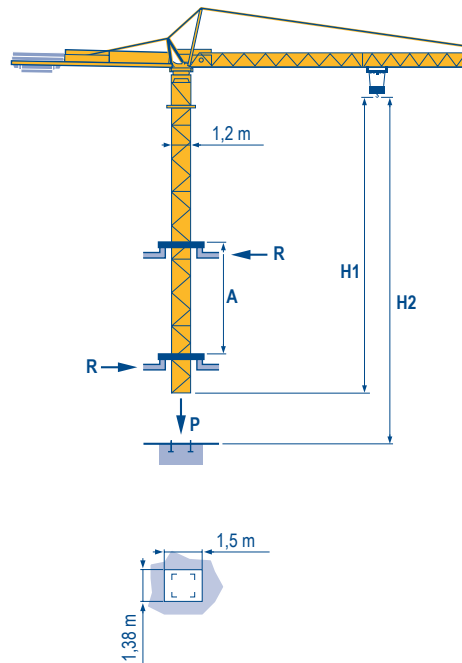

MBD 1

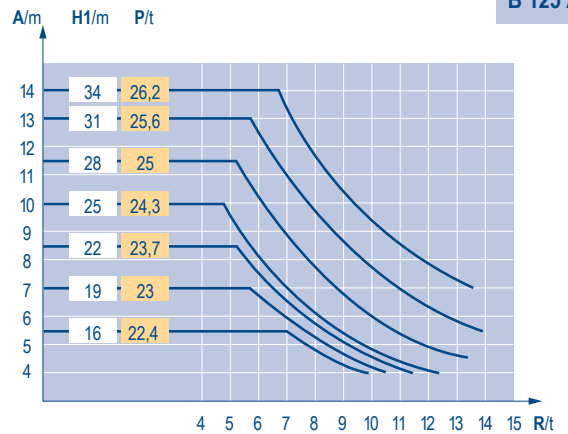

**B 125 A**

**CITY CRANE**  
**MC 58**

**POTAIN**

	F	D	GB	E	I	P
<b>A</b>	Distance entre cadres	Abstand zwischen den Rahmen	Distance between collars	Distancia entra marcos	Distanza fra i telai	Distância entre quadros
<b>H1</b>	Hauteur grue	Kranhöhe	Crane height	Altura grúa	Altezza gru	Altura da grua
<b>P</b>	Poids de la grue(en service)	Krangewicht (in Betrieb)	Crane weight (in service)	Peso de la grúa (en servicio)	Peso della gru (in servizio)	Peso da grua (em serviço)
<b>R</b>	Réaction horizontale	Horizontalkräfte	Horizontal reaction	Reaccion horizontal	Reazione orizzontale	Reacção horizontal
	Voir télescopage sur dalles	Siehe Kletterkrane im Gebäude	See climbing crane	Veja grua trepadora	Consultare gru in cavedio	Ver telescopagem sobre lages

Mécanismes  
Antriebe  
Mechanisms  
Mecanismos  
Meccanismi  
Mecanismos

MBD 3

						ch - PS hp	kW	
	15 PC 13 AC-1	m/min	7,1	21	42	15	11	130 m
		t	2,5	2,5	1,3			
	25 PC 13 AC-1	m/min	7,9	31,5	63	25	18	229 m
		t	2,5	2,5	1,3			
20 LVF 13	m/min	5 →	31 →	57 →	20	15	230 m	
	t	2,5	2,5	1,3				0,65
	3 D2 V5	m/min	21 - 42			3	2,2	
	RCV 40	tr/min U/min rpm	0 → 0,8			6	4,5	
	ZE - ZF 	TVD 324	26			2 x 4	2 x 2,9	
	ZC - ZFC 	RT 224	25			2 x 4	2 x 2,9	
		CEI 38	IEC 38			kVA		
		400 V (+6% -10%) 50 Hz			15 PC : 25 kVA 25 PC : 35 kVA 20 LVF : 30 kVA			

F	D	GB	E	I	P
Levage	Heben	Hoisting	Elevación	Sollevamento	Elevação
Distribution	Katzfahren	Trolleying	Distribución	Distribuzione	Distribuição
Orientation	Schwenken	Slewing	Orientación	Rotazione	Rotação
Translation	Kranfahren	Travelling	Traslación	Traslazione	Translação

Document commercial non contractuel. Pour toute information technique se référer à la notice correspondante. Unverbindliches Vertriebsdokument. Für technische Informationen, siehe die entsprechenden Anweisungen. This commercial document is not legally binding. For any technical information, please refer to the corresponding instructions. Documento comercial non contractuel. Para cualquier información técnica, ver la noticia correspondiente. Documento commerciale non vincolante, per tutte le informazioni tecniche fare riferimento al catalogo istruzioni. Documento comercial não contratual. Para qualquer informação técnica complementar consultar as respectivas instruções.



**Americas**  
Tel : +1 888 479 7278  
Tel : +1 717 593 2000

**Europe - Middle East - Africa**  
Tel : +33 (0) 4 72 81 50 00  
Tel : +44 (0) 191 522 2000

**Asia - Pacific**  
Tel : +65 6264 1188  
Fax : +65 6862 4040

www.manitowoccrane.com

**18, rue de Charbonnières - B.R.173**  
**69132 ECULLY Cedex - France**  
Tél. : +33 (0) 4 72 18 20 20  
Fax. : +33 (0) 4 72 18 20 00  
www.manitowoccrane.com

**CITY CRANE MC 58**  
Code W-89985-17\_Réf. 2004 12 MBD 6

Copyright.Reproduction interdite © POTAIN 2004

Réalisation Secdoc